

Making solar simple



The next generation renewable power

Scatec introduces Release, a flexible leasing agreement of pre-assembled and containerised solar PV and battery equipment, securely integrated with power infrastructure.

www.releasesolar.com

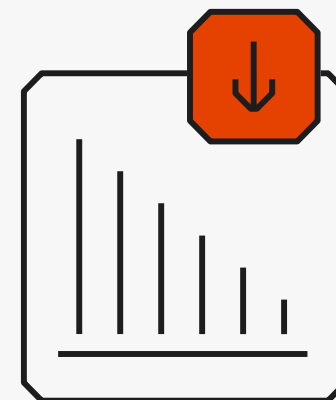

Reduced energy costs



Flexible contract duration
Limited upfront investment

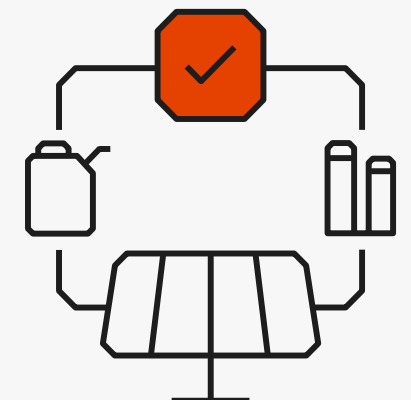

Reduced fuel dependency

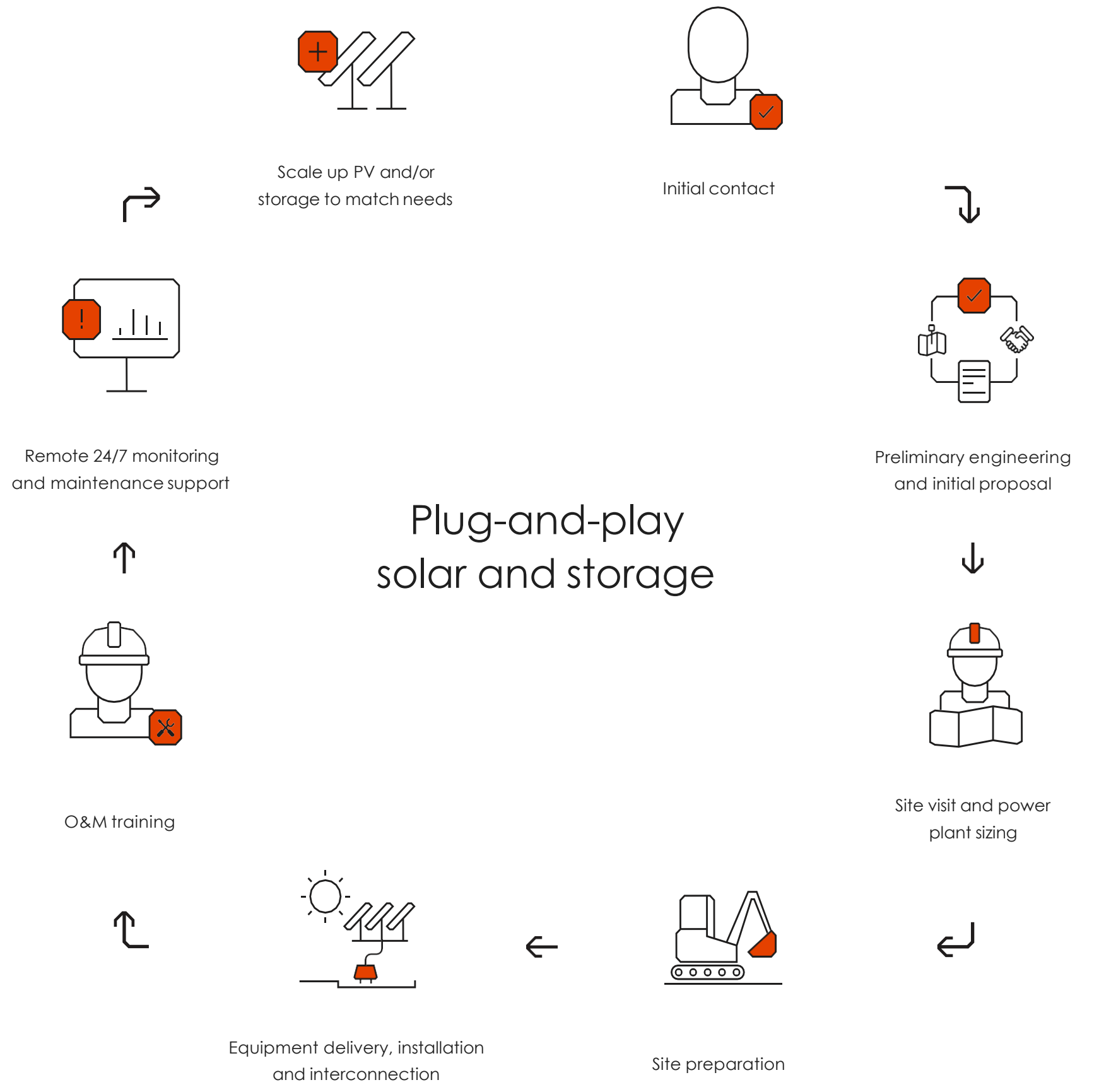
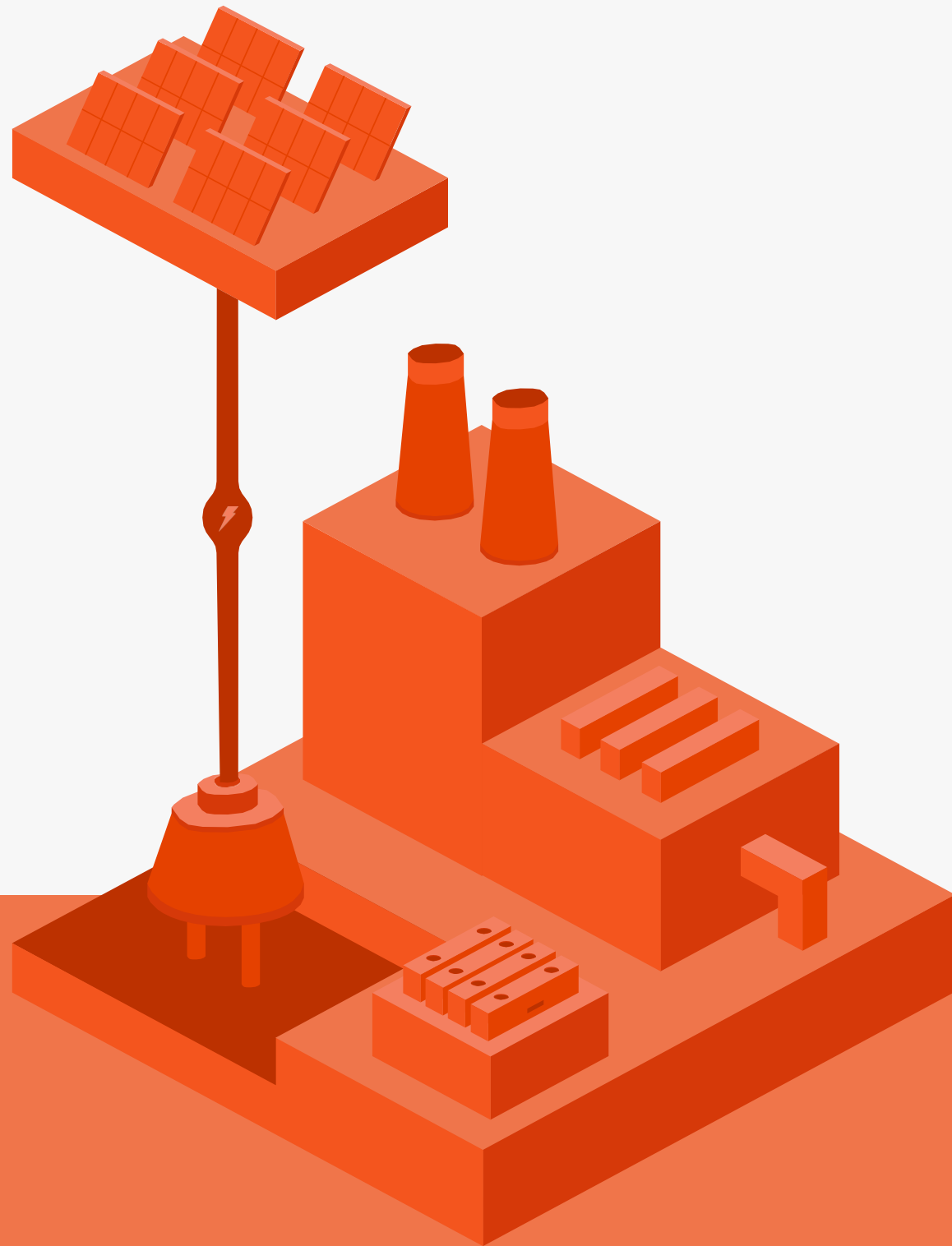



Guaranteed performance and availability
Release guarantees equipment performance and availability to ensure predictable power production.

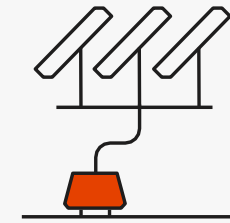

Quick deployment and installation
Standardised, pre-assembled & containerised equipment reduces design requirements and installation time.



Solar trackers and bifacial modules for high efficiency
Our solar systems produce 30% more power than traditional fixed systems at the same installed capacity.

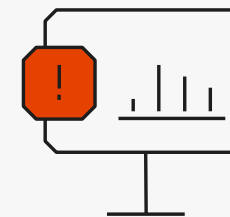

24/7 technical support and monitoring
We provide remote 24/7 monitoring, analysis, and maintenance from our Control and Monitoring Centre in Cape Town.

Technical specifications

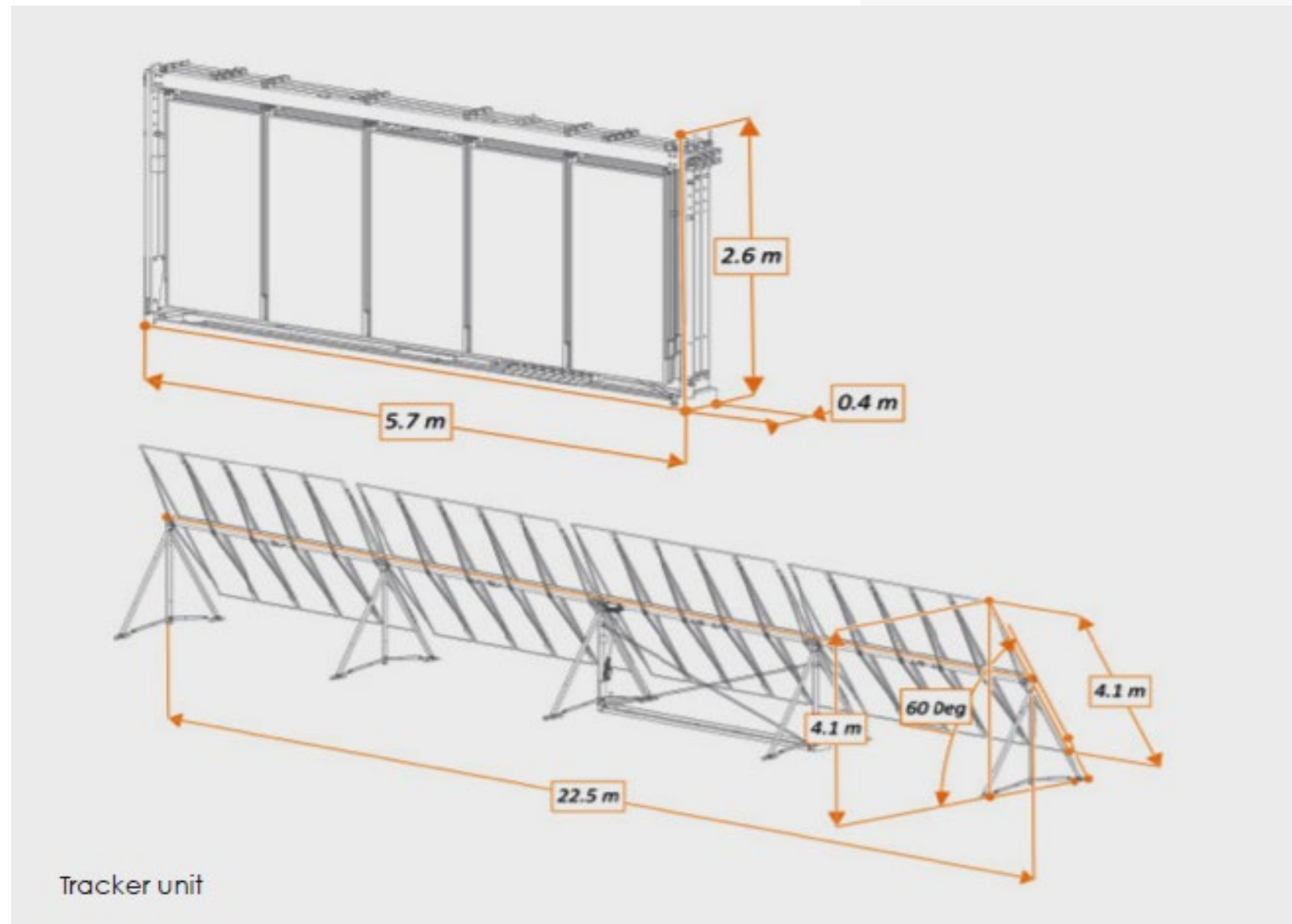

Redeployable solar tracker unit

Type	Independent row horizontal single axis with backtracking
Range	60 degrees (East-West)
Drive system	Linear actuator
Control	Wireless communication, automatic stowing at high wind speeds
Configuration	2 portrait
Unit weight	< 2,500 kg
Anchoring	Ground anchors suitable for most ground conditions

Solar container

Container	40' High Cube
Trackers	10 tracker units, from 152 kW
Modules	400, pre-mounted
Module type	72 cell mono-perc, bifacial, glass-glass, 380-400 Wp
Inverters	2 String inverters

Scalable solar block

Standard block	5 containers
Land requirement	From 1.5 ha/MWp (with 10m row spacing)
DC capacity	From 760 kWp (module dependent)
AC capacity	660 kVA
LV output	Single output AC combiner, 380-480 V
MV output	As required, to site voltage level. Compact miniature substation
Scalability	By multiples of standard block

Technical specifications

Energy management system

Compatibility	Grid/off-grid
Applications	Solar, energy storage, thermal (diesel, HFO)
Control	Ensuring stability of power supply and optimised solar dispatch

Energy storage

System	Standalone battery and inverter cabinets including Battery Management System
Technology	Lithium-ion. Pre-assembled, skid mounted or containerised
Charge/discharge power	Scalable from 100 kW to several MW
Capacity	Scalable from 400 kWh to several MWh
Discharge duration	From 2C (0.5 hour) to 0.25C (4 hours)
Lifetime	10-15 years to 70% residual capacity

